



**Built In Electric Multifunction Oven and
Grills, with Genus Functions.**

GENUS

Please retain these instructions for future reference.
Visit www.stoves.co.uk for info and ideas.

Welcome to Genus

Congratulations on choosing the Stoves Genus!

Genus is quite simply the the ultimate cooking machine. For starters, it's an excellent Multifunction cooker in it's own right, with scores of features.

But what makes Genus a genuine revolution, is it's ability to not only produce beautiful results but, to do so on average four times faster.

And here's how. . . .

Unlike any other cooker, Genus works by combining conventional cooking methods with it's own exclusive Genus heating technology. Put simply food is cooked much more evenly, consistently and with much greater efficiency without any compromise on the results.

All you have to do is select the appropriate programme.

We have produced this handbook to accompany the Stoves Genus, to take you through it's functions successfully. In order to appreciate the full benefits of your new oven, it is best to read through these instructions fully, and to pay particular attention to the 'Safety Information' located at the back of this book.

We hope you find Stoves Genus an attractive and beneficial addition to your lifestyle.

Stoves Genus: Revolutionary cooker, remarkable results

Contents

User Guide	
Introduction	2 -6
Using the Genus Function (main oven only)	7 -17
Quick Start Guide	7
About Genus	8
Genus Functions - Programme Tables	9 - 10
Genus Functions - Foods which need special care	11
Genus Functions - Information	12
Genus Functions - Recommended Cookware	13
Getting Started with Genus (Functions 1 - 7)	14 - 15
Using Genus Function 8 - reheat	16 - 17
Using the Genus Functions with Automatic Programming	18
Genus Functions - Important Safety Notes	19
Using the Multifunction Oven (main oven only)	20 - 28
Getting Started	20
Symbols & Recommended Uses	21
Cookware & Bakeware	22
Pre-heating & Other Notes	23
Multifunction Cooking Guide	24 - 25
Multifunction Roasting Guide	26
Defrosting & Slow Cooking	27
Main Cavity Shelving	28
Using the Grills	29 - 35
Introduction	29
Top Cavity Grilling	31
Top Cavity Grilling Guide	34
Top Cavity Shelving	35

Contents

Using the Conventional Oven (top oven only)	36 - 39
Introduction	36
Symbols & Recommended Uses	37
Top Oven Notes	38
Top Oven Cooking Guide	39
Automatic Programming	40
Additional Features	44
Cleaning	45
Trouble Shooting	50
Setting the Clock	51
Changing Light Bulbs.	52
Customer Care	53
Frequently Asked Questions	55 - 55
Safety Information.	56 - 57
Cook Shop	58
Service Record	59
Installation Guide	60 - 64
Step 1 - Preparation	60 - 61
Step 2 - Connect to the Electricity.	62
Step 3 - Fitting the Edging Strip	63
Step 4 - Securing the Appliance	63
Installation Notes	64
Technical Data	65

Introduction

2

i Before using the appliance.

Remove any protective polythene film and wash the oven shelves and furniture in hot soapy water to remove their protective covering of oil.

Even so, when you first turn on the oven or grill you may notice a smell and some smoke, this is normal, harmless and quite common.

i First Steps

Note: When the appliance is first switched on it goes into self test mode for 30 seconds.

The appliance will then go into stand-by mode, and will show the time of day and the ambient temperature in °C.

To turn the appliance on, push the on/off control knob in the centre of the control panel:



The icons on the fascia will illuminate in red to show you available selections. These icons are touch buttons, and when touched will activate functions. In order fully understand your fascia you will need to familiarise yourself with it, there are tables on the following pages to help you with this.

Don't be afraid to touch any of the function icons on the fascia and turning them on (they will turn green) to experiment with them. You won't damage the oven, and you can always turn them off by touching them again, turning them back to red.

If you want to start again, just press the on / off control knob to turn the appliance off. You can then switch it back on whenever you like.

You can do this as often as you want until you feel comfortable with the touch buttons and control knob.

Introduction

3

Icons



Red icon means the function is in Standby mode and is available for selection.



Red flashing icon means the function must be selected.



Green icon mean the function is in use.





Orange icon means the function is in use, but the other oven's cooking information is being display - more on this later on in the handbook.

The Control knob

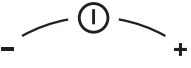

The on / off control knob is used to enter information into the displays located to the left and right of the control knob. Information is entered by turning the knob and applies to all oven functions where required.

Icon	Explanation
	<p>On / Off icon located above the centre control knob press the control knob to turn the appliance on and off.</p>
	<p>To increase time / temperature located to the right of the centre control knob, turn the control knob towards + to increase times / temperatures.</p>
	<p>To decrease time / temperature located to the left of the centre control knob turn the control knob towards - to decrease times / temperatures.</p>

Introduction

4

Timer Display



The time display on the right is used for:

- Showing the time of day.
- Entering recipe or convenience food timings for the Genus Functions - it will flash to show you need to enter this.
- In the Genus Function it will also show the calculation being worked out by the computer i.e. 'CAL 2'
- In the Genus Function it will also show seconds only when counting down the final cooking minute.
- Entering cook times and end times for automatic programming- it will flash to show you need to enter this.

Temperature Display



The temperature display on the left will show the temperature of the oven, even when it is not in use.

Introduction

Your Stoves Genus

Main Oven functions

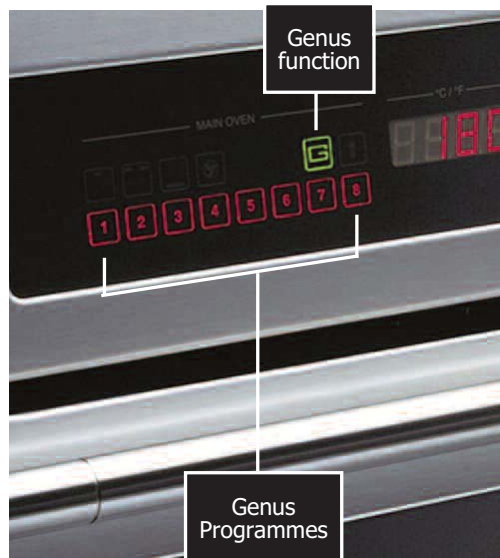
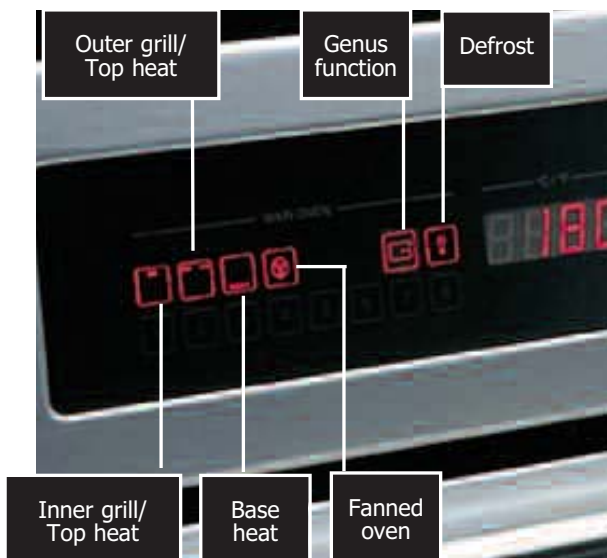





Icon	Explanation
	Inner Grill / Top Heat
	Outer Grill / Top heat
	Base heat
	Fanned oven
	Genus Function
	Genus Function programmes 1 - 8
	Defrost

Introduction

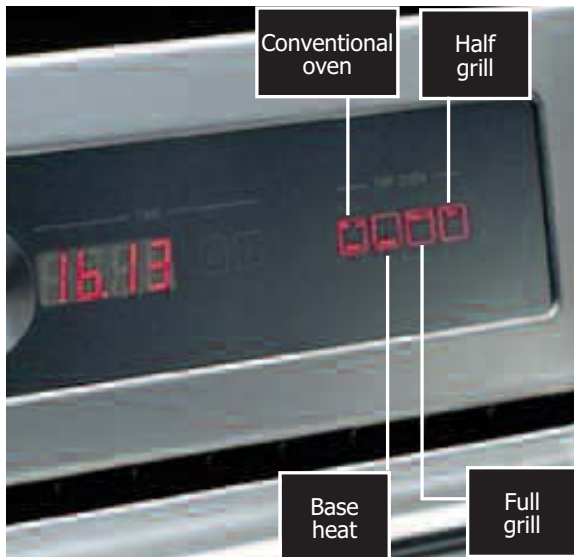
Your Stoves Genus

Top Oven & Grill functions



Icon	Explanation
	Base heat
	Conventional oven
	Half / Economy grill
	Full / Dual grill

Using the Main Oven Genus Function 7

This section is dedicated to using the Genus Functions.

About Genus

The Genus Function is a rapid cook method which combines a revolutionary heating technology with traditional cooking and baking methods - allowing you to cook several times faster than you usually would in your oven.

Time can be saved cooking many items, some examples of time savings can be found in the table below.

Genus Programme	Dish / Item	Conventional Cooking time (mins)*	Genus Cooking time (mins)	No of times faster (x)	Time saved (mins)
4	Fish (Salmon)	50	10	5	40
5	Full Roast chicken	95	35	3	60
1	Baked potatoes x 8	105	35	3	70
5	Roast Beef 1kg	90	25	4	65
2	Frozen pizza	30	5	6	25
2	Fresh scone	30	4	8	26

* includes 15 minutes pre-heat time

As the Genus Functions do **not** require pre-heating, this also saves on time and energy, in addition, the Genus Functions allow you to combine a number of features - without compromising on taste.

There are a variety of tables and recommendations we suggest that you follow while using the Genus Functions, these are here to guide you when you use Genus, and will help you make the most of using the functions available to you. You may have already used the Quick Start Guide, but if you haven't, take the time to get to know your appliance and become familiar with the way it works.

Always remember that if you ever want to start again from the beginning - all you have to do is press the on / off control knob.

Using the Main Oven Genus Function

8

Quick Start

Five simple steps to remarkable results.

Why not try something simple for the first time, like a frozen pizza?

- Step 1** Place your food inside the oven on the 6th shelf up, push the on/off control knob to switch on the appliance.
- Step 2** Select the Genus Function by touching the red "G" touch button. It will then turn green.
- Step 3** The eight available Genus Functions will turn red, touch the programme you wish to use, for frozen pizza - programme 2 or, see the table on pages 9 and 10 for other foods. It will then turn green.
- Step 4** The display on the right of the on / off control knob will start to flash. This means you need to enter information, in this case the cooking time as it appears on the recipe or packaging. You can do this by turning the on / off control knob. The Genus Function will now calculate the cooking time for you.

You have a limited time to enter in the cooking time, so make sure you have the recipe or packaging handy. If you run out of time, simply press the on / off control knob and start again from the beginning, you can do this as often as you need until you are comfortable with the time you have.

- Step 5** A tone will sound 3 times signalling that the Genus programme is in it's last minute of cooking - and the clock will count down in seconds. When this finishes, the oven goes into stand by mode, and you can add extra time if you want to.
- If you need to add some more time, turn the on / off control knob clockwise to add extra minutes.
 - If your food is to your satisfaction, you can turn off the oven by pressing the on / off control knob and then remove your food.

Remember, you can take your food out before cooking time has finished if you prefer - or add extra time. It's up to you!

Once you have successfully completed your first meal, you will be ready to fully develop your Genus skills - for more ideas and details see the 'Using the Genus Function' section.

Using the Main Oven Genus Function

9

* Shelf positions are always counted from the bottom to the top - see page 24 for more information - and are extremely important when using the Genus Functions.

When using Genus, please be aware the thinner foods should go on a higher shelf than thicker foods. This means that the Genus heat will reach the food properly and give you the best possible results.

Category	Food item	Shelf*
1 General	Puddings - fruit crumble, bread and butter	5
	Sausage rolls (fresh)	5
	Chilled croissant	5
	Baked potatoes	6
	Baked apples	5
	Home made lasagne & pasta dishes	5
	Roast sweet potatoes	6
	Beef Wellington (individual)	5
	Roasted root vegetables	6
	Hot Pot	5
	Home made puff pastry pies	5
2 Rapid	Oven chips	6
	Frozen pizza - all weights, thicknesses and sizes	6
	Chilled pizza - all weights, thicknesses and sizes	6
	Scones	5
	Bread - all types / sizes	1
	Bread rolls	3
	Fish cakes - home made	6
	Gratin dishes	5
3 Cakes	Whisked sponge (2 x 180mm/7")	6
	Victoria sponge (2 x 180mm/7")	6
	Madeira cake	6
	Semi rich fruitcake	4
	Coconut and cherry loaf (2 lb)	3
	Very rich fruit cake (7")	3

Using the Main Oven Genus Function

10

Category	Food item	Shelf*
4 Fish & Braised	Fish - whole Braised dishes Fish - cutlets / fillets Fish - all types Fish pies - pastry and potato topped Baked fish Fish - en papillot	6 6 6 6 6 6 6
5 Meats	Meat (roasted) Poultry (roasted)	5 5
	You must always use the trivet provided! See page 13 for description.	
6 Gentle	Rice pudding (made with cold milk) Baked custard (made with cold milk) Slow roasted tomatoes	5 5 6
7 Convenience	Chilled convenience meals Frozen convenience foods - excluding pizza Frozen & chilled pies (sweet and savoury)	5 - 6 5 - 6 5 - 6
		Shelf position depends on the thickness of the food/ depth of the dish.
8 Reheat	Plated meals Meals in medium dishes Meals in small dishes	8 6 5

Using the Main Oven Genus Function

11



Not all foods are suitable for cooking with the Genus Function.

<ul style="list-style-type: none"> Do not boil eggs in this oven! Steam will build up inside the yolk and explode causing injury. 	<ul style="list-style-type: none"> Sealed jars/containers may explode and should not be heated in the oven.
<ul style="list-style-type: none"> Foods with a high salt content (Thick Gammon etc.) are not suitable for cooking using the Genus Function - use the multifunction oven instead. 	<ul style="list-style-type: none"> Foods with a high sugar content (such as Meringue etc.) are not suitable for cooking using the Genus Functions - use the multifunction oven instead.

Some foods require special attention while cooking:

- Over cooking potatoes can lead to them dehydrating and catching fire. Please make sure that you regularly check them while they are cooking.
- Foods with an unbroken outer skin, such as;
 - sausages,
 - egg yolks,
 - tomatoes,
 - potatoes
 - liver (including giblets etc).

When cooking foods like the above, you must make sure you have pierced the outer skin before you start to cook them.

Using the Main Oven Genus Function

12

If the food you wish to cook is not in any of the previous tables, you should always remember that the Genus Functions are calculated based on the type of dish being cooked.



Type of dish is what food your dish/meal is mostly made from. There may be other ingredients, but always go on the one that makes up the bulk of the dish, for example pasta, potato or meat.

Using the table given on pages 9 and 10, see where you think your food is most likely to be.

For example, a meat based pie would be cooked on the meat programme.

Follow the 'Using the Genus Function' instructions to get started.

It is a good idea to keep checking the dish as it cooks, just to make sure it does not over, or under cook.

You can always add to, or reduce the cooking time as needed - and you can take the dish out at any point during cooking if you want to. As with any cooking, it's all down to personal taste.

Notes:

You should be aware however, that it is not possible for you to combine the Genus Functions - you can only use one at a time, for example you couldn't use the meat programme (5) combined with the general programme (1).

You could however surround your roasting joint with the vegetables you wish to roast - they must be in the same roasting tin - and use the meat programme (5) to roast them all.

If you need to, you can always give the vegetables a little longer in the oven while the meat is resting before carving.

Alternatively, there is always the top oven for roasting vegetables separately.

You may notice that cooking times are further reduced when you cook several items, one after the other using the Genus functions.

This is because the Genus function takes into account the residual heat inside the oven from previous cooking. This will also lead to time savings.

Using the Main Oven Genus Function

13

Recommended cookware

Some plastics and papers will combust if used with the Genus Functions, due to the higher temperatures. Whereas metal covered roasters will prevent the Genus heat from reaching the food, and therefore cancel out any time savings.

You also should not fully wrap foods, the ovens shelves, or base in aluminium foil - this too will cancel out the Genus heat.

You can however use:

- ✓ Glass cookware.
- ✓ China cookware.
- ✓ Metal roasting tins, baking trays and cake tins.

There is bakeware supplied with your Stoves Genus which is suitable for use with the Genus Functions. The Roasting tin you should always use has a trivet with holes in it and is specially designed to work with the Genus Functions to give you the best results.

When you clean the roasting tin and trivet, it is important to replace the trivet correctly, before using it again. The trivet must be replaced so that the trims point downward. Please see the illustrations below:

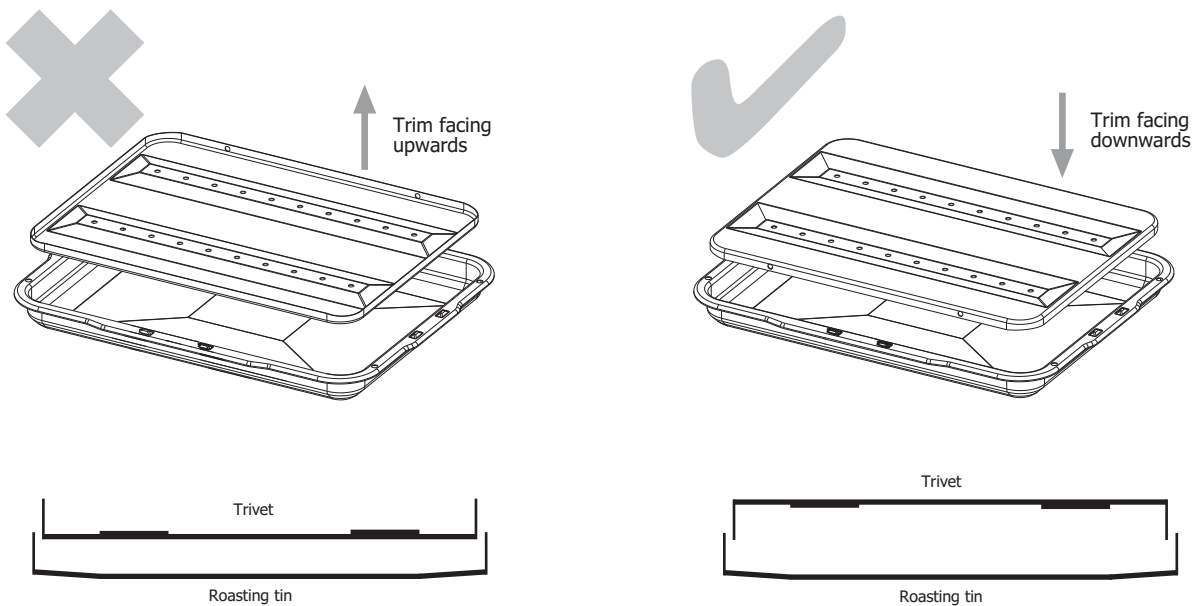

Using the Main Oven Genus Function

14

Getting started with the Genus Functions (1 -7)

The Genus Function is one of the functions available for the main oven. It is activated by using the touch buttons on the fascia, and once you are familiar with it, it becomes easier to use each time.

Once the on/off control knob has been pressed to switch on the appliance, the fascia illuminates everything in red.

- To use the Genus Function, touch the "G" icon and it will turn green.



- Once the "G" has turned green, the numbered categories below will begin to flash red, signalling the you can select any of them - depending on the food you wish to cook.



Use to the tables on pages 9 and 10 to help you find out which function you require. We would suggest that you do this before you start cooking, until you are familiar with the functions and the food types which use them.

Always use the shelf positions recommended in the guide.

- These numbers will only flash when the Genus Function is selected.

You have a limited time to enter in the cooking time, so make sure you have the recipe or packaging handy. If you run out of time, simply press the on / off control knob and start again from the beginning, you can do this as often as you need until you are comfortable with the time you have.

- The timer display on the right of the on/off control knob will then flash, signalling that a time needs to be entered.



The time you enter should be the recommended time on the package, or in the recipe. If more than one time is given (minimum and maximum) use the shortest time. Extra time can be added at the end. **Do not amend these times.**

Using the Main Oven Genus Function

15

- Once the category has been chosen, the temperature display on the left hand side of the control knob will show a temperature selected by the programmer. This has been set up to give you the optimum performance, but don't be afraid to adjust this to suit your personal taste by turning the on/off control knob to increase (clockwise) or decrease (anti clockwise).
- After a couple of seconds, the display will change colour showing that the programme has been accepted and the new cooking time will be calculated. The timer display shows CAL while calculating, followed a few seconds later by the reduced cooking time.
- At the last minute of cooking time, a tone will sound 3 times signalling the cooking time is nearly over, from this point the timer display will show the seconds counting down. When time has elapsed the appliance goes into standby mode (approx. 4 minutes long) to allow you to add extra time, if desired. This switches off the elements but leaves the lights and cooling fan on.
- If you "choose" to increase the time by turning the control knob clockwise, then the oven continues cooking. If you do not want, or need, to add any time simply turn off the oven by pressing the on / off control knob and remove your food.

As with a conventional oven you can still:

- Adjust times and temperatures by using the control knob to increase or decrease.
- Remove food before the end of the programme if it is done to your liking.
- Check your food while it is cooking, or stir, by opening the door.
The left hand display will flash with the word 'DOOR' to act as a reminder that the door is open, once you have finished your checks and closed the door fully, the display will show the temperature again. This will not affect the running of the Genus Function you are using as it will pause while the door is open.

While the door is open, you will not be able to select any functions for the top oven, this is normal and is due to the left hand display being used to show the word 'DOOR' - once the door is closed, you can select those functions.

Using the Main Oven Genus Function

16

Using Genus function 8 - Reheat

As with the other 7 functions, this function **will** re-calculate your cooking times for you.

How to use the reheat function.

- Touch the "G" icon until it turns green.
- Once the "G" has turned green, the numbered categories below will begin to flash red, signalling the you can select any of them - to select reheat touch the number 8.
- Using the table on page 10, see which type of reheated meal suits your dish best. i.e. is it a plated meal?
- The timer display on the right of the on/off control knob will then flash, signalling that a time needs to be entered. You should enter the time you expect it will take the meal or dish to reheat - please take into account things like the amount of food on the plate, and the thickness of the plate/cookware and the type of cookware. Genus will then calculate the new, reduced time.
- You can add to the reheat time if you feel it has not been long enough, or you can take food out early if you feel it is heated enough. We recommend that you check the food regularly while it is cooking.
- At the last minute of cooking time, a tone will sound 3 times signalling the cooking time is nearly over, from this point the timer display will show the seconds counting down. When time has elapsed the appliance goes into standby mode (approx. 4 minutes long) to allow you to add extra time, if desired. This switches off the elements but leaves the lights and cooling fan on.
- If you "choose" to increase the time by turning the control knob clockwise, then the oven continues cooking. If you do not want, or need, to add any time simply turn off the oven by pressing the on / off control knob and safely remove your food.

Using the Main Oven Genus Function

17

Using Genus function 8 - Reheat Notes:

As with any reheating you must :

Always make sure your plates and dishes are ovenproof.

Always make sure that the food is piping hot before you serve it.

Always eat reheated food as soon as it is ready.

Never reheat any foods more than once.

You can check your food as often as you want while it is reheating to ensure that it does not over or under heat.

For some dishes, particularly those which are liquid or sauce based, we recommend that you stir the dish half way through reheating - this will ensure that it is reheated right through.

Always make sure that all dishes are reheated underneath some kind of cover to prevent foods drying out. An upturned plate, or dish cover is ideal, but you should not use aluminium foil, or plastic wraps (cling film) as they are not suitable for use with the Genus functions.

Using the Main Oven Genus Function



18

Using the Genus Functions with the programmer

Due to the nature of the Genus Functions, they operate in semi automatic mode all of the time (i.e. the oven switches itself off at the end of the programme). You can however also programme it to switch itself on (fully automatic) at a time when you are not there so food is ready for you upon your return.

- Once you have selected the Genus Function, the category and temperature you wish to use, enter the cooking time as stated on the packaging or recipe. The programmer will calculate the new cooking time after a couple of seconds.

The oven will now be operational.

- The cook time icon will light up in green. If you do not want to use the fully automatic programmer - do nothing else. 
- If you want to use the fully automatic programme wait for the end time icon light up in red. Touch this icon and it will turn green, telling the programmer you want to set an end time. 
- Then you should enter the time of day (i.e. 17.30) that you want the food to be ready at. Once this has been selected, the oven will calculate a start time based on the Genus Function's calculations.
You do not need to worry about working out the start time yourself.

The oven will now 'power down' and switch off.

- To cancel the automatic cooking function - touch the end time icon twice in succession.

To amend any of the timer functions, touch the icon for that function twice or until it flashes for a short period of time while you make your adjustments - then store the changes.

Using the Main Oven Genus Function

19

Important safety notes:

Arcing

Arcing, sparks in the oven, is caused by the following:

- Metal or foil touching the side of the oven cavity.
- Foil not moulded to foods acting as an antenna.
- Any gold rimmed dishes, metal twist ties or poultry pins inside the oven.
- Some recycled paper products - they may contain metal particles.

Some arcing is inevitable and should you spot any sparks open the oven door and correct the problem where possible before continuing to cook. Please do so carefully taking care to avoid any elements, hot shelving and hot dishes.

When Using the Genus Functions there are several items you **must not** use:

- ✘ Anything with a plastic or paper wrapping, unless it is suitable for use with very high temperatures
- ✘ Plastic containers or bowls, unless it is suitable for use with very high temperatures
- ✘ Plastic cookware, unless it is suitable for use with very high temperatures
- ✘ Wooden equipment should not be used, or left in the oven.
- ✘ Covered metal roasters.

Super heated water and spontaneous boiling.

Some liquids may have been heated beyond boiling point with no visible signs. Take care when removing liquids from the oven, or stirring them as the liquid might suddenly boil over. This can cause serious burns.

Using the Multifunction Main Oven

20

Getting started with the Multifunction Oven

In addition to the Genus Functions, the main oven is also a multifunction oven.

In order to start using the oven in manual mode, first push the on/off control knob - this will light up all the functions available to you.



- Touch the icon for the function you wish to use, for example, fanned oven. 
- This selects your chosen function, and the icon will turn green. The remaining icons will stay red.
- Select the temperature you wish to use by turning the on/off control knob, either clockwise to increase the temperature, or anti clockwise to decrease the temperature.

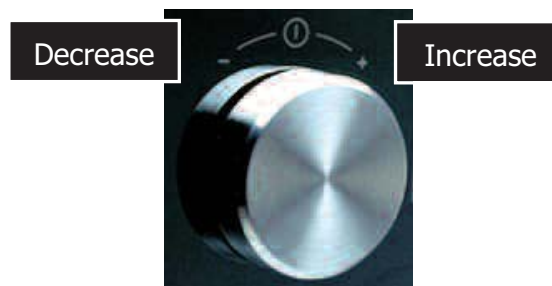

Stoves Genus' Multifunction oven has been pre-set with a variety of temperature in order to give optimum results, but you can adjust these if you find they do not suit your taste.

The oven **and** the grill have a temperature range from 40°C to 250°C, offering you a variety of temperature options.









After a few seconds the oven lights will illuminate, and the oven will start to work, this delay is perfectly normal for this appliance. You can then start cooking your food.

Condensation

When hot and cold air meet, condensation forms. The outer door is air cooled and the inner door gets hot, so some condensation might form; this is normal and will disappear within a few minutes.

Using the Multifunction Main Oven

21

Symbol	Notes	Recommended uses
	Touch the fan icon as well for fanned, top heat, if you choose. 	The top heat function in the top oven operates with an adjustable heat setting. The top heat function can be used towards the end of a cooking period to brown the tops of foods such as cauliflower cheese.
	Touch the fan icon as well for fanned, base heat if you choose. 	The base heat function in the top oven operates with an adjustable heat setting. The base heat function can be used towards the end of a cooking period to brown and crisp the bases of foods such as pizzas, pastry cases, quiche and pies. Base heat can also be used to cook dishes without a top crust such as jam tarts or open mince pies.
	Touch both	The zones of heat throughout the oven when it is used as a conventional oven , make this function suitable for traditional roasting. Place the meat towards the centre of the oven, roast potatoes towards the top and puddings towards the base.
	Touch both. Inner and outer heat/grill	For browning/grilling larger quantities of food e.g. lasagne or toasting, the top heat/'grill' can be utilised. The temperatures range between 40 and 250 °C. For more information see page 29.
	No need to pre-heat on certain items.	The even temperature throughout the fanned oven makes this function suitable for batch baking and batch cooking foods.
	No need to pre-heat	Details of the Genus Function are explained earlier in this handbook.

Using the Multifunction Main Oven

22

Bakeware and cookware

The following bakeware can be used with this multifunction oven:

- ✓ Glass cookware.
- ✓ China cookware.
- ✓ Covered roasters
- ✓ Metal roasting tins, baking trays and cake tins.
- ✓ Any other dish which is ovenproof.
- ✓ Any convenience food containers - please check the manufacturers instructions first.
- ✓ Always make sure that any dish you use to cook with is ovenproof.
- ✓ Always use good quality baking trays and roasting tins - poor quality utensils may warp in the oven, leading to poor results.
- ✗ Never use items which may melt or catch fire, i.e. wooden items or non ovenproof plastics.
- If you are roasting meats, you can cover the roasting tin with aluminium foil. However you should not wrap the oven shelves or cover the oven base with foil.

Using the Multifunction Main Oven

23

Pre-heating:

The main oven performs at it's best when pre-heated for some functions. The temperature display will change colour once pre-heating has finished.



Remember you do not need to pre-heat at all when using the **Genus Functions**.

When you use the **Fanned Oven** we recommend you do pre-heat for the following:

Chilled / Frozen foods.

Sensitive foods such as Yorkshire puddings or souffle.

For other food types there is no need to pre-heat.

Automatic operation

See the 'Automatic Programming' section which starts on page 40.

To switch off the oven:

If the icon is green, touch it once.

If the icon is orange, touch it twice.

This will de-select any functions you have been using.

To switch the oven off completely, press the on / off control knob. As with the Genus Function, you can switch the oven off this way at any time.

Using the Multifunction Main Oven

24

Note: For best results when using the conventional oven cooking function, only one tray of cakes or scone should be baked. When baking more than one tray, the fanned oven cooking function should be used. Shelf positions are counted from the bottom to the top (see page 28 for an illustration)

Dish	Recommended temperature (°C)		Shelf	Cook time
	Conventional	Fanned		
scone	220	200	6 & 12	8 - 15 mins
Meringue	120	110	2	2 - 3 hrs
Cakes				
	190	175	9	15 - 25 mins
Small Cakes	190	175	9	20 - 25 mins
Whisked sponge	205	190	5	10 - 12 mins
Swiss roll	180	160	7	20 0 30 mins
Victoria sandwich (2 x 180mm/7")	180	160	8	25 - 30 mins
Genoese sponge	170	150	5	1 - 1¼ hrs
Madeira (2 x 180mm/7")	140	125	5	2½ - 3hrs
Semi rich fruit cake (205mm/8")	140	125	5	2½ - 3hrs
Dundee cake (205mm/8")				
Pastry				
	220	200		
Flaky / Puff	200	180		
Shortcrust	200	180		
Choux	200	180		
Plate tarts (2 x 180mm/7")				
			Depends on recipe and type of filling	
Biscuits				
	180	160	10	10 - 20 mins
Shortbread rounds	180	160	9	35 - 40 mins
Nut brownies	190	170	11	8 - 12 mins
Brandy snaps	190	180	9	25 - 40 mins
Flapjacks	180	160	11	15 - 20 mins
Ginger nuts				

Using the Multifunction Main Oven

25

Dish	Recommended temperature (°C)		Shelf	Cook Time
	Conventional	Fanned		
Puddings				
Rice pudding (1/2 pint dish)	150	140	6	1 ³ / ₄ - 2hrs
Baked custard (1/2 pint dish)	170	150	9	50 - 60 mins
Bread & butter pudding (1/2 pint dish)	170	150	9	³ / ₄ - 1 hr
Hot souffle	180	160	7	30 - 45 mins
Fruit crumble	190	175	9	40 mins - 1hr
Miscellaneous				
Yorkshire pudding large	220	200	11	40 - 45 mins
small	220	200	12	15 - 20 mins
Toad in the hole	220	200	11	40 - 45 mins
Bread				
2 x 1lb loaves	220	200	7	20 - 30 mins
bread rolls	220	200	10	10 - 15 mins

The shelf positions shown in the guide are for conventional cooking only.

The information contained in these table can be adjusted to suit personal taste when required.

Using the Multifunction Main Oven

26

Frozen meat should be thoroughly thawed before cooking. For large joints, it is advisable to thaw overnight.

Frozen poultry should be thoroughly thawed before cooking (unless packaging advises otherwise), the time required depends on the size of the bird - eg: a large turkey may take up to 48 hours to thaw.

Adjust the shelf positions so the meat or poultry will be in the centre of the oven when using the conventional mode.

The times given in the roasting guide are only **approximate** because the size and age of the bird will influence cooking times, as will the shape of the joint and the proportion of bone.

Cook in oven at :		Approximate cooking time (Preheated oven)
175°C - fanned oven		
190°C - conventional oven		
180°C - top oven		
Beef	Rare	20 minutes per 450g (1lb) plus 20 minutes.
	Medium	25 minutes per 450g (1lb) plus 25 minutes.
	Well done	30 minutes per 450g (1lb) plus 30 minutes
Lamb	Medium	25 minutes per 450g (1lb) plus 25 minutes.
	Well done	30 minutes per 450g (1lb) plus 30 minutes
Pork		35 minutes per 450g (1lb) plus 35 minutes
Poultry		20 minutes per 450g (1lb) plus 20 minutes

Using the Multifunction Main Oven

27

Defrosting



Press and release the on/off control knob to access the functions.

Touch the defrost only icon to select it as your choice.

You do not need to select a temperature when defrosting or cooling.

After a few seconds the oven lights will illuminate and the oven will start to operate.

To **defrost** frozen foods, place food in the centre of the oven and close the door.

Be safe

- Do not defrost stuffed poultry using this method.
- Always have some kind of container underneath the food you are defrosting, such as a roasting tin, in order to catch any water or juices from the defrosting food.
- Do not defrost larger joints of meat or poultry over 2kg / 4lb using this method.
- Never place uncooked food which is to be defrosted next to cooked food which is to be cooled, as this can lead to cross contamination.
- You can use the semi automatic programmer to time the defrost function - see 'Automatic Programming' page 41 - for more information.

Slow cooking

Press and release the on/off control knob to access the functions.

Touch the icons for either the conventional oven or fanned oven. Do not try to slow cook using any of the other oven functions.

For roasting joints of meat or poultry and for pot roasts, preheat the oven to 190°C - 200°C and cook for 30 minutes, then adjust the oven temperature control to 110 - 120°C for the remainder of the cooking time.

- Always use the top half of the oven when slow cooking in the main oven with the conventional oven function.
- Slow cooking times will be about three times as long as conventional cooking times.
- Make sure that frozen foods are thoroughly thawed before cooking.
- Do not slow cook joints of meat or poultry weighing more than 2¹/₄kg.

Main Oven Shelving

28

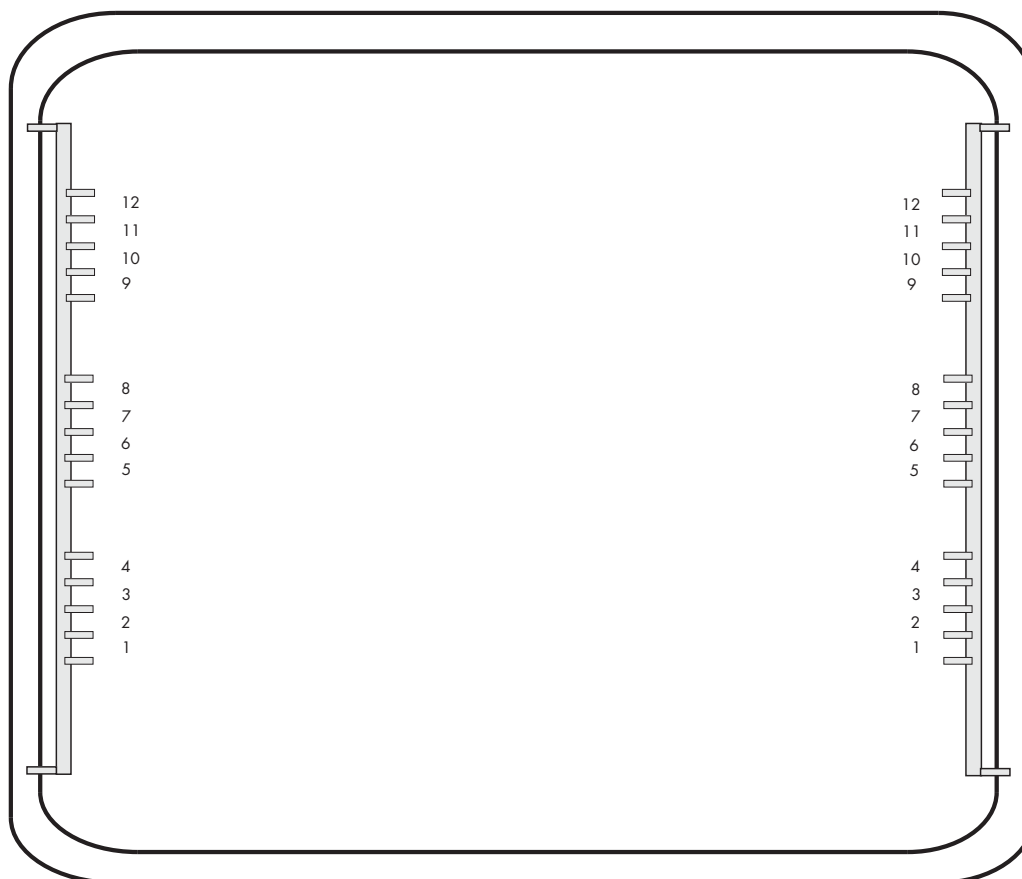

The main oven has twelve shelf positions inside, which are counted from the bottom up - as shown. The cooking guides in this handbook are accompanied by a recommended shelf position see pages 24 - 25 for details.

To help the air circulate freely

- Position the shelves evenly within the oven and maintain a clearance from the oven roof and base.
- If more than one cooking dish or baking tray is to be used on a shelf, leave a gap of at least 25mm between the items themselves and the oven interior.
- Allow enough space between shelves for food that will rise during cooking.
- *Do not* place items on the oven base as this will prevent air from circulating freely.

Using the Grills

29

Caution: Accessible parts may be hot when the grill is used, young children should be kept away.

Using the grills

Stoves Genus has a grill in both oven cavities, both are fully variable.

The main oven door must be kept **closed** while using the top heat/grilling in the main oven cavity.

The top oven door must be kept **open** while grilling in the top cavity.

Follow the instructions given on the next page when operating these grills.

This appliance performs at it's best when pre-heated.

When pre-heating the main oven top heat/grill, the left hand temperature display will change colour, from green to red, once pre-heating has finished.

When pre-heating the top oven grill, the left hand temperature display will show the selected heat setting in green. This will remain green throughout grilling. We recommend that you pre-heat the top oven grill for 3 - 5 minutes before use.

Notes on the main oven top heat/grill function

Both the main oven top heat functions are best suited to grill or brown large quantities of food. These functions have a temperature settings of between 40°C - 250°C.

These functions are operated in the same way as you would select any of the multifunctions, but please remember if you are using it as a 'grill', food will require checking while you are cooking to get the best results.

These functions can be controlled by the automatic programmer - see page 40.

Using the Grills

30

Aluminium foil

Using aluminium foil to cover the grill pan, or putting items wrapped in foil under the grill can create a fire hazard, and the high reflectivity can damage the grill element.

Detachable grill pan handle

Place the handle over the edge of the grill pan, at the narrow side edges. Slide the handle to the centre, and locate between the handle position indicators.

The handle should be removed from the pan during grilling, to prevent overheating.

The handle is designed for removing / inserting the grill pan under the grill when grilling.

If cleaning the grill pan when it is hot, use oven gloves to move it. *Do not* use the handle to pour hot fats from the grill pan.

Food for grilling should be positioned centrally on the grid.

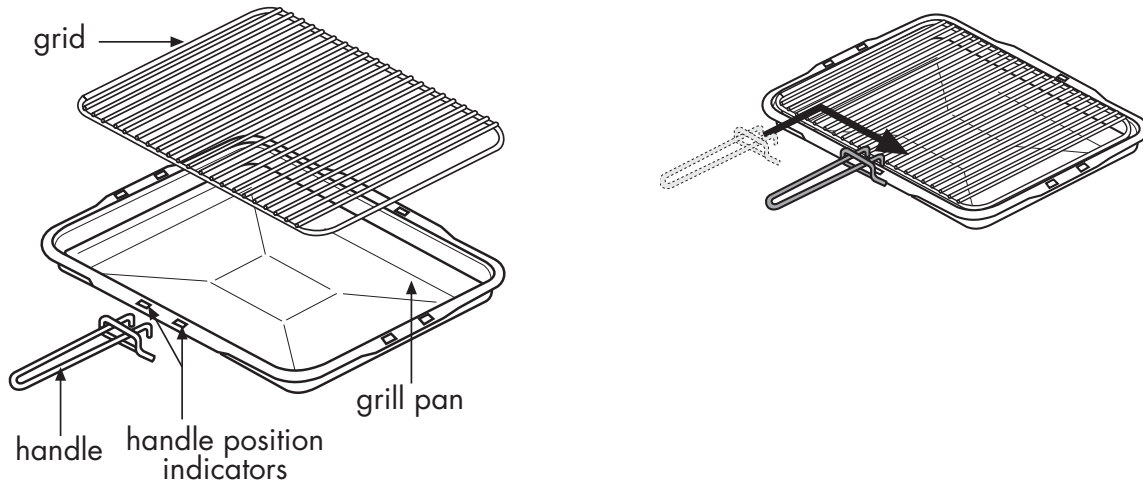

Grilling in the Top Oven

31

Grilling in the top oven

To give you more choice, the top oven grill is fully variable, meaning you can adjust the temperature when you want giving you a full range of temperatures to cook with. You can adjust the temperature to suit the thickness and quantity of foods you are cooking.

The grill in the top oven is regulated using temperature levels from 1 - 9.

To switch on the grill

Press the on/off control knob to switch the appliance on.



The icons will all light up red.

Using the touch buttons, touch the icon for the grill type you want to use:



Full grill



Economy grill

The economy grill settings only use the inner element of the grill.

The selected icon will turn green, while the icons not currently in use will remain red. The display on the left hand side of the on/off control knob will show the pre-set grill setting as **3** in red.

As with the other functions on the Stoves Genus, the heat setting can be changed.

Decrease

Increase



You can choose any grill setting between **1** and **9**. This is done by turning the on/off control knob left to decrease the setting, and right to increase the setting. You can do this whenever you want during cooking.

If you do not adjust the setting up or down within a few seconds it will automatically select **3** as the grilling level, this is the pre-set heat setting and it will remain on this throughout cooking if you don't adjust it.

Grilling in the Top Oven

32

To change functions

For additional flexibility, you can change between grill functions while the grill is in use, by touching the icon you wish to change to, this will automatically de-select the previous choice.

You must however, de-select the function you were using by touching the icon and ensuring it turns red, **if you are changing from Grilling functions, to Top Oven functions.** This also applies if you are changing from **Top Oven functions to Grilling functions.**

If you do not do this, the grill will continue to function as the first function you chose. The new function will not come on at all.

To switch off the grill:

If the icon is green, touch it once.

If the icon is orange, touch it twice.

This switches off the grill functions totally.

To switch off completely, press the on / off control knob. As with the Genus Functions and the Multifunction Oven, you can switch off the oven this way at any time.

Grilling in the Top Oven

33

Grilling in the top oven - notes

Important: The top oven / grill door must be kept open when the top oven grill is used - either fully open or using the door stop position - open the door about 75mm and it will hold open.

If the grill door is closed whilst the grill is in use, it will cause the grill door to become hot.

If, for whatever reason the grill door is closed while the grill is in use, the appliance will recognise this when the temperature becomes too hot inside the cavity. An alarm will sound, and on the display the words "OPEN" and "DOOR" will flash alternately. The alarm will continue to sound until either the door is opened or the grill is switched off.

The alarm will not sound if the grill has been switched off and is cooling down with the door closed.

Note: The grill **cannot** be controlled by the programmer.

It may take a few seconds for the grill lights, and the power to come on, please do not be concerned by this.

Grilling Guide for the Top Oven

34

The grilling times given in the guide are only approximate, as the difference in thickness, size of portion and personal preference will influence cooking times. The times given in the grilling guide are based upon the grill being preheated for a few minutes.

Shelf positions are always counted from the bottom upwards

Food	Shelf Position	Grid Position	Cooking Time
Bread			
Toast - 4 rounds	4	High	3 - 5 mins
Cheese on toast - 4 rounds	3 or 4	High	4 - 6 mins
Tea cakes	2 or 3	High	3 - 5 mins
Meat and Poultry			
Bacon rashers	4	High	7 - 10 mins
Sausages	3	High	14 - 18 mins
Steak - Rare	4	High	8 - 12 mins
- Medium	3	High	12 - 16 mins
- Well done	3	High	16 - 22 mins
Lamb chops	2	High	14 - 18 mins
Pork chops	2	High	15 - 20 mins
Gammon steaks	4	High	12 - 16 mins
Chicken fillets	2	High	15 - 20 mins
Fish			
Fish fillets	3	High	15 - 20 mins

Top Cavity Shelving

35

Top oven and grill shelving

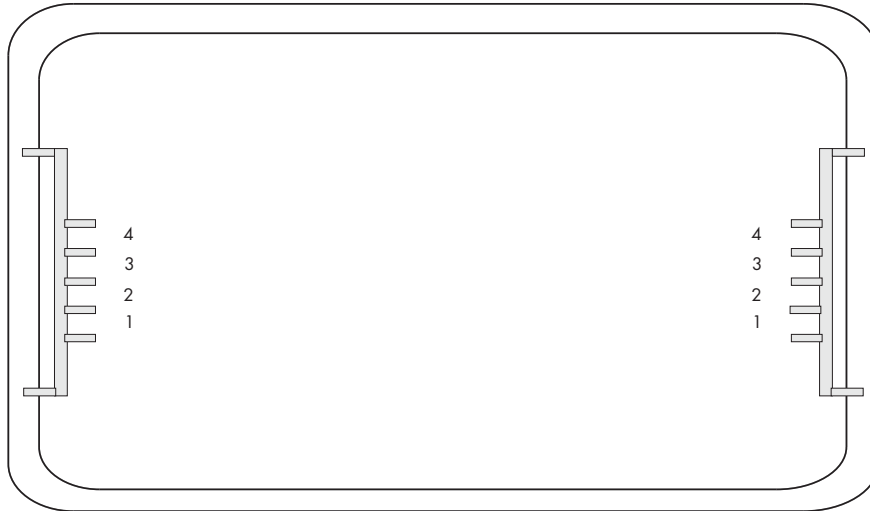

The top oven and grill has 4 shelf positions which are counted from bottom to top. You can also adjust the positioning of food by turning the grid in your grill pan. The cooking guides in this handbook are accompanied by a recommended shelf position see page 29 for details on grilling and page 36 for details on the top oven.

Using the top oven grill..Hints and tips

For grilling smaller quantities of food the (single element) economy grill can be utilised. This grill function can be controlled between settings 1 and 9.

For grilling larger quantities of food, the full grill can be utilised. The full grill can also be controlled between settings 1 and 9, or use the main oven grill.

When using the grill in the top oven, the speed of grilling can be controlled by use of either the variable control or by selecting higher or lower shelf position.

For toasting, and for grilling foods such as bacon, sausages or steaks, use a higher shelf position.

For thicker foods such as chops or chicken joint pieces, use a middle to low shelf position.

To give further choice and control, the grid in the grill pan can be inverted before use to place food lower down in the grill pan.

Using the Top Oven

36

Caution: Accessible parts may be hot when the top oven is used, young children should be kept away.

The Stoves Genus also has a conventional top oven, which may also be used as base heat only.

Manual operation

Manual operation is when there are no automatic programmes running, and you must switch on and off the oven.

Pre heating

The top oven is at it's best when pre-heated. The temperature display will change colour, from green to red, once pre-heating has finished.

To switch on the top oven

Press the on/off control knob to switch on the appliance.



Touch the icon for the top oven function you wish to use.

The icon will then turn green. The remaining icons will remain red.

See the guide on the following page for more information.



Base heat only



Conventional oven

Select the temperature you wish to use, by turning the on/off control knob.

The temperature can be adjusted by using the on/off control knob. Turn the on/off control knob anti clockwise (-) for reducing the temperature and clockwise (+) for increasing the temperature.

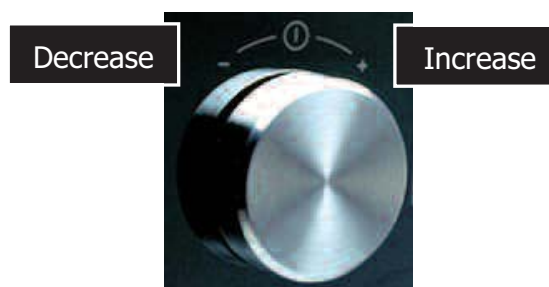





The top oven temperatures have been pre-set in order to give optimum results, but you can adjust these if you find they do not suit your taste.

After a couple of seconds, the oven lights will illuminate and the oven will begin to operate.

Using the Top Oven - functions

37

Symbol	Recommended Uses
	The base heat function can be used towards the end of a cooking period to brown and crisp the bases of foods such as pizzas, pastry cases, quiche and pies. The base heat setting can also be used to cook dishes without a top crust such as jam tarts or open mince pies.
	The conventional oven function is ideal for cooking smaller portions than you would in the main oven. The temperature in the oven varies, with the top being slightly hotter due to heat rising, and the base slightly cooler. You can cook a variety of meals, small pieces of fish and meat, and some kinds of baked foods with this function.
	For grilling smaller quantities of food the (single element) economy grill can be utilised. This grill function can be controlled between settings 1 and 9.
	For grilling larger quantities of food, the (dual element) full grill can be utilised. The full grill can also be controlled between settings 1 and 9.

Using the Top Oven

38

To change functions

While the oven is working, touch the icon you wish to change to, this will turn green to show you have selected it, the previous icon will go red, showing it has been de-selected.

You must however, de-select the function you were using by touching the icon and ensuring it turns red, **if you are changing from Top Oven functions, to Grilling functions.** This also applies if you are changing from **Grilling functions to Top Oven functions.**

If you do not do this, the grill will continue to function as the first function you chose. The new function will not come on at all.

To switch off the oven:

If the icon is green, touch it once.

If the icon is orange, touch it twice.

Important notes

- Important: Never put items directly on the base of the oven or cover the oven base with foil, as this may cause the element to overheat.
- Caution: The grill gets extremely hot when the top oven / grill is in use, so take extra care to avoid touching it.
- Should you wish to change functions during cooking to improve results, or to suit your personal taste, you can do so at any point.

Note: The oven has a temperature range from 40 °C to 250 °C, to give you a full choice of temperature options.

Automatic operation

See the 'Automatic Programming' section which starts on page 40.

Using the Top Oven

39

Please note the cooking times, and information given below are approximate and may be adjusted to suit personal taste. Oven shelf positions are counted from the bottom to the top.

Dish	Recommended temperature (°C)	Shelf	Cook time
Scone	215	6 & 12	10 - 15 mins
Meringue	110	2	2 - 3 hrs
Cakes			
Small Cakes	180	9	15 - 25 mins
Whisked sponge	180	9	20 - 25 mins
Swiss roll	200	5	10 - 12 mins
Victoria sandwich (2 x 180mm/7")	170	7	20 0 30 mins
Genoese sponge	180	8	25 - 30 mins
Madeira (2 x 180mm/7")	160	5	50mins - 1¼ hrs
Semi rich fruit cake (205mm/8")	140	5	2½ - 3hrs
Dundee cake (205mm/8")	140	5	2½ - 3hrs
Pastry			
Flaky / Puff	220 - 210	Depends on recipe and type of filling	
Shortcrust	200 - 210		
Choux	200 - 210		
Plate tarts	200 - 210		
(2 x 180mm/7")			
Biscuits			
Shortbread rounds	170	10	10 - 20 mins
Nut brownies	180	9	30 - 40 mins
Brandy snaps	190	11	8 - 12 mins
Flapjacks	190	9	25 - 40 mins
Ginger nuts	180	11	15 - 20 mins

Automatic Programming

40

Notes of importance when automatic or semi-automatic cooking:

The timer display will show the end time while the auto programmer is running.

- On the last minute of cook time the audio sounds. From this point onwards, the timer counts down in seconds.
- You can programme both ovens to cook simultaneously.
When you are programming both ovens at the same time, the function icon for the first programme you set will be displayed as orange on the fascia.
- If you have programmed both ovens, please be aware that you may only view one oven at a time. The function which is lit green is on view and is active, whereas the orange lit icon is active, but not on view. To view, touch the icon until it turns green.
- When the cook time has elapsed the appliance goes into standby mode (approx. 4 minutes long) to allow you to amend the time, if desired. This switches off the elements but leaves the lights and cooling fan on. If you "choose" to increase the time, then the appliance continues cooking.
- If you "choose not" to amend the time then the appliance shuts down.

To cancel the automatic programmer:

- Cancelling 1 oven. Touch the illuminated icon for the oven you wish to cancel, ensuring it turns red. You may need to touch the icon twice.
- Cancelling 2 ovens. Press the on/off control knob. This will stop the programme in both cavities.

Automatic Programming

41

Using the Multifunction Main Oven and Conventional Top Oven

Semi Automatic cooking - Duration method

Semi-Automatic cooking procedure for both Main and Top oven:

Use the procedure below, then wait a few seconds for the timer to store the information.

- Select the function you wish to use, once touched the icon will turn green. You can use any function (including defrost) in either oven for semi-automatic cooking - apart from the grills.



- The temperature display on the left hand side will begin to flash, signalling that you should either adjust the temperature, or leave it at the pre-set temperature. Use the on/off control knob to set the temperature you require for cooking.

Please be aware the oven is now operational.

- The cook time icon has now illuminated, once touched the icon will turn green.



- When the timer on the right flashes, enter your required "cooking time". (Minimum of 1 minute)
As this is semi automatic cooking, you have only set the length of time you want the oven to remain on for. You must leave the timer for 5 seconds, this enables it to store all of the information.
- You can programme both the top and main ovens, they will turn off at different times if required, and will not affect each other in any way.
- To programme the second oven, repeat the above procedure.

If you have programmed more than one oven, and wish to view the different settings simply touch the function icon on the oven you wish to look at - once it turns green, you are looking at the information for that programme. This also applies for fully automatic programming - which is explained on page 43.

Automatic Programming

42

Using the Multifunction Main Oven and Conventional Top Oven

Semi Automatic Cooking continued.

At the last minute of cooking time, a tone will sound 3 times signalling the cooking time is nearly over, from this point the timer display will show the seconds counting down.

At the end of cooking time, the alarm will sound for 15 seconds, the oven lights will remain on and the function icon will flash for approximately 4 minutes, during this time you can extend the cooking time if it is needed, by turning the on/off control knob.

If no more cooking time is required, please turn off the oven, and make sure nothing is left on.

We recommend that if you are using the Automatic cooking function for the first time, you remain close by in order to keep checking that everything is working to your satisfaction.

If you should encounter any difficulties, please make sure you have followed the procedure outlined in this book.

For Genus Function programming see page 14.

Automatic Programming

43

Using the Multifunction Main Oven and Conventional Top Oven

Fully Automatic cooking

Automatic cooking procedure for both Main and Top oven:

Use the procedure below, then wait a few seconds for the timer to store the information.

- Select the function you wish to use, once touched the icon will turn green. You can use any function in either oven for semi automatic cooking - apart from the grills, and defrost. 
- The temperature display on the left hand side will begin to flash, turn the on/off control knob to set the temperature you require for cooking.

Please be aware the oven is now operational.

- The cook time icon has now illuminated, once touched the icon will turn green. 
- When timer flashes enter your required "cooking time". (Minimum of 1 minute).

As this is fully automatic cooking, you have to set the time you would like the oven to switch off at.

- Touch the end time icon, it will turn green confirming that it has been selected. The oven will then switch off. 
- Using the on/off control knob, enter in the time of day (i.e. 17.30) that you would like the oven to turn off at.

Remember: This is a 24 hour clock.

- Leave the timer for 5 seconds, to allow it to store the information. It may seem like the oven has shut down, but this is part of the fully automatic cooking programme. The oven will turn itself on at the pre-set time, which has been calculated by the programmer.

Additional Features

44

Lights Only mode.

You can turn just the oven lights on with Stoves Genus.

- To switch on the lights only, press and hold the on / off control knob for 5 seconds.
- To switch off the lights, press and hold the on / off control knob until the lights turn off.

This is particularly useful when you are cleaning the oven cavity.

Volume Control / Adjustments

To suit your needs you can adjust the volume of everything (touch button tones and alarm tones) on Stoves Genus, to do this:

- Press the on / off control knob.



- Then touch and hold the '8' icon.

8

The beeper will sound continuously, you can then adjust the volume by turning the on / off control knob clockwise - to make it louder, and anti-clockwise - to make it quieter.



Once you have made your choice, take your finger off the '8' icon.

8

This can be re-adjusted at any time you like.

Cleaning

45

Caution: Any cleaning agent used incorrectly may damage the appliance.

Always let the oven cool before cleaning.

Some cooking operations generate considerable amount of grease, this combined with spillage can become a hazard if allowed to accumulate on the oven through lack of cleaning. In extreme cases this may amount to misuse of the appliance and could invalidate your guarantee.

It is recommended that the appliance is cleaned after open roasting.

Do not use caustic, corrosive or abrasive cleaning products, products containing bleach, coarse wire wool or any hard implements, as they will damage the surfaces.

All parts of the appliance can be safely cleaned with a cloth wrung out in hot soapy water.

In order to make cleaning the oven cavities and sides easier, it is possible to turn on just the lights. This can be done by pressing and holding the on/off control knob until the lights in both cavities illuminate.

Chrome plated parts

oven shelves & oven shelf runners, grill pan grid

Do not use abrasives or polishes, use a moist soap pad - e.g. "Brillo". These items may also be cleaned in a dishwasher.

Note: Oven shelf runners can be removed for cleaning. Grasp the runners, and slide out of the hanging holes as shown.

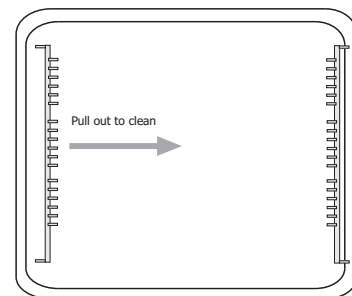

Pristine Enamel Parts

oven cavities

We recommend that the appliance is cleaned after open roasting. Use of a trivet in a roasting tin when roasting will help reduce fat splashing.

Use a few drops of washing up liquid in hot water. Wipe the surfaces with a clean cloth wrung out in hot soapy water - if larger splashes of fat do not readily disappear, use a mild cream cleaner i.e. "Cif". Stubborn marks can be cleaned off using a soap filled pad - e.g. "Brillo".

Cleaning

46

Inner Door Glass parts

Use a mild cream cleaner - e.g.; "Cif". Rinse thoroughly and dry with a soft cloth. Do not use abrasive cleaners or polishes.

Top Oven and Grill only

To remove the glass panel for cleaning, open the door to the door stop position (about 30° open), hold the top and bottom edges of the panel and slide out. Note that if the door is opened fully when removing the inner door glass panel, the door may spring shut.

Important: if the inner door glass panel is removed for cleaning, it must be replaced the right way up as shown, and pushed fully into the stop position.

Glass panels

To meet the relevant Standards of Domestic cooking appliances, all the glass panels on this appliance are toughened to meet the fragmentation requirements of BS3193. This ensures that, in the unlikely event that a panel breaks, it does so into small fragments to minimise the risk of injury.

Please take care when handling, using or cleaning all glass panels as any damage to the surfaces or edges may result in the glass breaking without warning, or apparent cause at a later date. Should any glass panel be damaged, we strongly recommend that it is replaced immediately.

Please call Customer Care to arrange a service engineers visit, and **do not** use the appliance until it is repaired.



The main oven is shown above, but the same applies for the top oven.

Cleaning

47

External Glass parts

Top & Main oven door glass - stainless steel models

Fascia panel - stainless steel models

Use hot, soapy water on stubborn marks.

Use a mild cream cleaner - e.g.; "Cif". Rinse thoroughly and dry with a soft cloth. Do not use abrasive cleaners or polishes.

External Glass parts

Top & Main oven door glass - black glass models

Fascia panel - black glass models

Use hot, soapy water on stubborn marks.

Use a mild cream cleaner - e.g.; "Cif". Rinse thoroughly and dry with a soft cloth. Do not use abrasive cleaners or polishes.

Please take care when handling, using or cleaning all glass panels as any damage to the surfaces or edges may result in the glass breaking without warning, or apparent cause at a later date.

As the oven doors are made of glass, should any glass panel become damaged, we strongly recommend that it is replaced immediately.

Please call Customer Care to arrange a service engineers visit, and **do not** use the appliance until it is repaired

Cleaning

48

Main Oven Inner Door Choke

Main Oven - all models

The main oven does not have a removable inner glass, however you can clean the glass by removing the door choke. Take care when removing the door choke not to damage it - if the door choke becomes damaged please call for a service engineer.

The door choke is teflon coated, and we recommended that you clean it with soap, warm water and a cloth. Dry carefully using a soft, clean cloth.

Do not use anything abrasive, wire pads or cleaners such as 'Cif', on this part as it might lead to damage - which will compromise it's performance.

Do not clean the door choke in a dishwasher

The door choke is removed by sliding it out of the door frame while the oven door is open, preferably to the door stop position (about 30° open), hold the top and bottom edges of the choke and slide out. Note that if the door is opened fully when removing the door choke, the door may spring shut.

The door choke is replaced by sliding it back into the door frame. Always make sure you have pushed the choke in as far as it will go to prevent damaging it or the door frame.



Important: You must make sure the choke is replaced before using the appliance again.

Cleaning

49

Painted, plastic and metal finish parts

door frame & handle, control knob

Only use a clean cloth wrung out in hot soapy water.

Stainless Steel surfaces

fascia panel, handles, door panels

Only use a clean cloth wrung out in hot soapy water, and dry with a soft cloth.

Stubborn marks can be removed using a stainless steel cleaner. We recommend that you clean the whole of the stainless steel area to maintain a uniform finish. Supplies can be purchased from the Customer Care Centre.

Do not use undiluted bleach, any products containing chlorides, or cleaning creams such as 'Cif', as they can permanently damage the steel.

Extra care should be taken when cooking food in salted water. Some foods are corrosive - e.g.; vinegar, fruit juices and especially **salt** - they can mark or damage stainless steel if they are left on the surface. Turn off and wipe any spillage immediately, taking care to avoid skin contact with any hot surface or spillage.

Sharp objects can mark the surface of stainless steel, but marks will become less noticeable with time.

To maintain the finish of the stainless steel, or to remove any greasy marks, wipe the stainless steel surface sparingly with a *minimum* amount of Baby Oil and kitchen paper.

Do not use cooking oils, as these may contain salt, which can damage the stainless steel surface.

Trouble shooting

50

- **In the event of a power cut**

Should there be a power cut, or interruption to the power supply, the appliances timer/control function is fitted with a back up battery. Therefore the time and date should return to correct setting once power is restored.

- **If "F1", "F2", "F3" and "F4" appear in the temperature display and the appliance will not work.**

This means there is a fault with the appliance - you must call our Customer Care Centre for a Service Engineer visit.

- **When using the Genus Function, you find your food is overcooked.**

Next time you cook the same meal - reduce the cooking time, or take food out earlier. As with any cooking, most success depends on personal preferences.

- **When using the Genus Function, you find your food is undercooked.**

Next time you cook - lengthen the cooking time, or add extra time at the end. Again, most success depends on personal preferences.

For Frequently Asked Questions see pages 53 & 53.

Common Sandwich cakes and sponge problems

- **Domed top**

Insufficient creaming of mixture, cake baked on too high a shelf position or at too high a temperature. Paper liners can cause the outer edge not to rise and the centre to peak.

- **Hollowed / sunken top**

Too much raising agent, oven temperature too low or incorrect shelf position, cake removed from oven before it is cooked, or use of soft tub margarine.

- **Close / doughy texture**

Too much liquid or too little flour or too much sugar. Insufficiently creamed, not enough raising agent, ingredients too warm, or insufficient air incorporated during mixing.

Common Pastry problems

- **Hard and tough**

Insufficient fat, too much liquid, over baking, or oven too cool.

- **Soggy**

Too much liquid, oven too cool, insufficient baking, lack of steam vent, or filling too hot when covered by pastry.

- **Shrinking**

Over-stretched during rolling and shaping, or insufficient resting time.

Setting the Clock

51

Timer Function.

If adjustment is required to the clock, please follow the instructions below:

- Press rotary control knob to switch on the appliance.



- Touch and hold (for 10 seconds) the cook time icon, located on the right hand side of the timer display. The icon will light once activated.

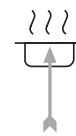

- YEAR will then appear in the left hand display. Turn the control knob until the correct year is set.



- CAL will be shown on the left hand display. Turn the control knob until the month is correct.



- The word DAY will appear on the left hand display. Set day of the week by turning the control knob, using the following codes:

- 00 – Sunday
- 01 – Monday
- 02 – Tuesday
- 03 – Wednesday
- 04 – Thursday
- 05 – Friday
- 06 – Saturday



- DATE will appear on the left hand display. Turn the control knob to set the correct date. Indicator will flash until stored.



- HOUR will appear on the left hand display. Turn the control knob to set the correct hour. Indicator will flash until stored.



- Set minutes. Indicator will flash until stored.

Changing Light Bulbs

52

Not all appliances have the same number and type of bulbs. Before replacing your bulb, open the top/main oven door and see which type you have. Then use the table below to help you change your bulb correctly.

Please remember that bulbs are not covered by your warranty.

Bulbs can be purchased from hardware stores (always take the old bulb with you).

Warning: There is a danger of electric shock. Always make sure that your appliance is switched off before you change the bulb.

Number of bulbs	Position & details	Changing instruction
2	Sides Top Oven 25W bulb	<ul style="list-style-type: none"> ● Switch off the electricity supply, (making sure that the oven cavity is cool) and remove the shelves. ● Grasp the lens cover and pull away from the side of the oven. Unscrew the bulb and replace.
2	Sides Main Oven 10W halogen bulb	<ul style="list-style-type: none"> ● Switch off the electricity supply and wait until the oven is cool, then remove the oven shelves. ● Unscrew the lens, taking care to avoid touching the lamp itself, as this may cause damage. ● Pull out the bulb and replace with a new halogen bulb. ● Do not touch the new halogen bulb with your bare hands as this will affect the life span of the new bulb.

Our Warranty

Should you need it



Inside the paperwork which has come with this appliance, there is a leaflet and card explaining the terms of our extended warranty and guarantee.

In order to apply for our five year guarantee, simply fill in the details on the card and post it off, this will register your appliance.

Should you wish to take out extended warranty, please fill in the details on the leaflet and post this off to:

**Glen Dimplex Australia,
Unit 2, 205 Abbots Road
Dandenong South
Victoria 3175
Australia**

If your appliance is covered by the warranty and guarantee, you will not be billed for work undertaken should your appliance be faulty, terms and conditions do apply, so please read through the literature carefully.

Please ensure that you have available your appliances model number and serial number, there is a space at the back of this book for recording that information.

Questions & Answers

54

Q How will Genus benefit me?

A If you've had a busy day and don't feel like cooking, you don't have to wait 15 minutes for the oven to pre-heat. You can also cook food straight from frozen and, for the ultimate in convenience, programme the oven to come on when you're out and have the food ready for you when you get home.

Genus cooks food beautifully in a fraction of the time it takes to cook conventionally, saving precious time and effort. Whether you are a novice cook or an expert, Genus makes the cooking process effortless – all the intelligence is built-in.

Q Does the way this cooker works affect the quality of the food; like a microwave?

A There are no adverse effects on any type of food. Genus is kind to food and won't alter its texture in the process of speeding up cooking.

In tandem with the three conventional sources of heat, the Genus Program reduces cooking times and helps cook food more thoroughly and evenly. Furthermore, cooking times are easier to judge, making ideal results simpler to achieve.

Q Do I have to pre-heat the oven?

A No. In Genus mode you can cook from cold or even frozen, saving precious time and providing greater efficiency.

When using as a conventional or multifunction oven, pre-heating is advised, as you would a normal oven.

Q I enjoy cooking and like to take my time. Will this cooker change that?

A No. You can use Genus as a top-of-the-range multifunction cooker. Genus has been programmed to produce beautiful results at normal speed as well.

So when you want to cook in the conventional way, you can – and when you want to cook something in a fraction of the time, you can do that too. Total flexibility for modern living.

Questions and Answers

55

Q If it's up to four times faster, how do I calculate the cooking times of everything?

A You don't. All the cooking times for various foods are pre-programmed so that all you have to do is input the kind of dish you're preparing and the conventional cooking time.

Genus will then select the recommended temperature and recalculate the time. But remember, you can always manually adjust the temperature and time selected by Genus at the touch of a button – you have ultimate control.

Q Is it just for cooking convenience food?

A No. Genus has been specifically programmed to cook the most popular dishes, whether it's a casserole, the traditional Sunday roast or a frozen pizza.

It is designed to save precious time by reducing the cooking time by a quarter or more. We think that it takes convenience food to another level – there is no longer a trade-off situation between speed and performance.

Q What if the food I want to cook isn't in the pre-programmed menus?

A Genus works from the main ingredients in the dish, so all pasta dishes for example would be the same programme. All main food types are covered in the pre-set menu, so there should never be a problem. But of course, you can adjust the time and temperature at any point during cooking if required.

Safety Information

56

General oven safety

When you are cooking, keep children away from the vicinity of appliance.

This product is designed as a domestic cooking appliance for the preparation and cooking of domestic food products, and should not be used for any other purpose.

- Remove all packaging from the appliance before using for the first time.
- Make sure you read and understand the instructions before using the appliance.
- Keep electrical leads short so they do not drape over the appliance or the edge of the worktop.
- Keep all flammable materials (such as curtains, furnishings & clothing) away from the appliance.
- Parts of the appliance may be hot during or immediately after use. Care should be taken to avoid touching heating elements inside the oven. Allow sufficient time for the appliance to cool after switching off.
- When opening the appliance door, take care to avoid skin contact with any steam which may escape from the cooker.
- Do not use aluminium foil to cover the grill pan, or put items wrapped in foil under the grill, as this creates a fire hazard. The high reflectivity can also damage the element.
- Do not use the ovens with the door inner glass panel removed, or the door choke removed (see the Cleaning section for more information).
- Do not drape tea towels over the flue vents or doors, as this creates a fire hazard.
- Use oven gloves when removing hot food / dishes from the oven or grill. The oven / grill and utensils will be very hot when in use.
- Do not use foil on oven shelves, or allow foil to block the oven flue as this creates a fire hazard preventing good heat circulation.
- When cooking heavy items - e.g.; turkeys - do not pull the oven shelf out with the item still on the shelf.
- Drop-down doors: Do not place items on the door when open.
- Switch off the electricity supply before replacing the oven light bulb, to avoid the possibility of electric shock.
- Never use the appliance for heating a room.

All installation, servicing and maintenance work should be carried out by a competent person who will comply with current Regulations, Standards and Requirements - see the Installation section at the rear of this handbook.

Warning: This appliance must be earthed.

When you have finished cooking check that the appliance is switched off.

Safety Information

57

Safety notes for the accelerated cooking functions Please read carefully and keep for future reference

- **Warning:** This appliance can **NOT** be used as a Microwave.
 - **Warning:** It is hazardous for anyone other than a service engineer to carry out any service or repair which involves the removal of the back cover of this appliance.
 - **Warning:** If the door or door seals are damaged this appliance **must not** be used until a qualified service engineer has repaired it.
 - **Warning:** Liquids and other foods must not be heated in sealed containers since they are liable to explode.
 - **Warning:** Only allow children to use this appliance when they are supervised, or when adequate instructions for use have been given enabling the child to use the oven in a safe way, and understand the hazards of improper use:
 - When heating food in paper, or plastic wrappings always keep an eye on the oven due to the possibility of combustion.
 - You cannot use this appliance for heating beverages, feeding bottles or baby food - these kinds of items are not suitable.
 - Eggs in their shell and whole hard boiled eggs should not be heated using the Genus Function as they may explode - even after the Genus Function has finished.
 - If smoke is observed, and it has nothing to do with the food items being cooked, switch off or unplug the appliance and keep the door closed to stifle any flames.
- Please be aware that some dishes may cause splashes of fat to land on the oven cavity, if this occurs in moderation, there is no need to turn off the oven.
- **Do not completely enclose food in foil, or use covered roasters as this will prevent the Genus Function working correctly. You may use covered dishes which have glass lids.**
 - Details for cleaning:
 - The oven should be cleaned regularly and deposits of food should be removed.
 - Failure to maintain the oven in a clean condition could lead to deterioration of the surfaces adversely affecting the life of the appliance and possibly resulting in a hazardous situation.

Installation

60

Electrical connection

Please refer to installation instructions for electrical connection.

In your own interest, and that of safety, make sure that the installation is carried out by a competent person.

Disconnection of electric appliances should always be carried out by a competent person.

Warning: This appliance must be earthed.

Step 1: Prepare installation

Do not lift the oven by the door handle.

Whilst every care is taken to eliminate burrs and raw edges from this product, please take care when handling - we recommend the use of protective gloves during installation.

Please note that the weight of this appliance is approximately **62kg** (unpacked). Take care when lifting it into the housing unit - always use an appropriate method of lifting.

If this appliance is to be installed near to a corner where the adjacent cabinets run at right angles forward of the appliance, there must be a gap of at least 90mm between the appliance and the cabinets, to prevent overheating of the cabinets.

1. Remove the fixing screws from the polythene bag on the top of the appliance, but leave the appliance in the base tray packaging until you are ready to install it.

Note: When removing the appliance from the base tray packaging care should be taken to ensure the outer frame trim is not damaged.

2. (i) When installed in a typical 600mm deep built in housing unit, the false back should be removed from the housing unit, to provide the necessary depth for installation.
 - (ii) When the false back is removed, it is normally the case that the support shelf for the appliance leaves a gap between the back edge and the wall of approximately 80mm.
 - (iii) If no gap occurs between the back edge of the shelf and the wall behind the unit, we recommend that a gap of at least 30mm is made by shortening the shelf.

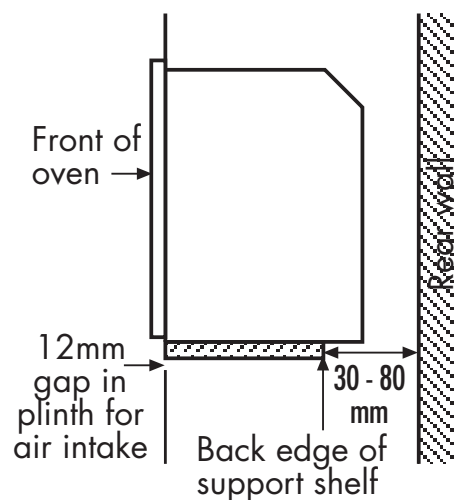

Installation

61

3. The appliance is designed to fit into a standard 600mm wide housing unit, with minimum internal dimensions as shown.

Please note that all sizes are nominal, some variation is to be expected.

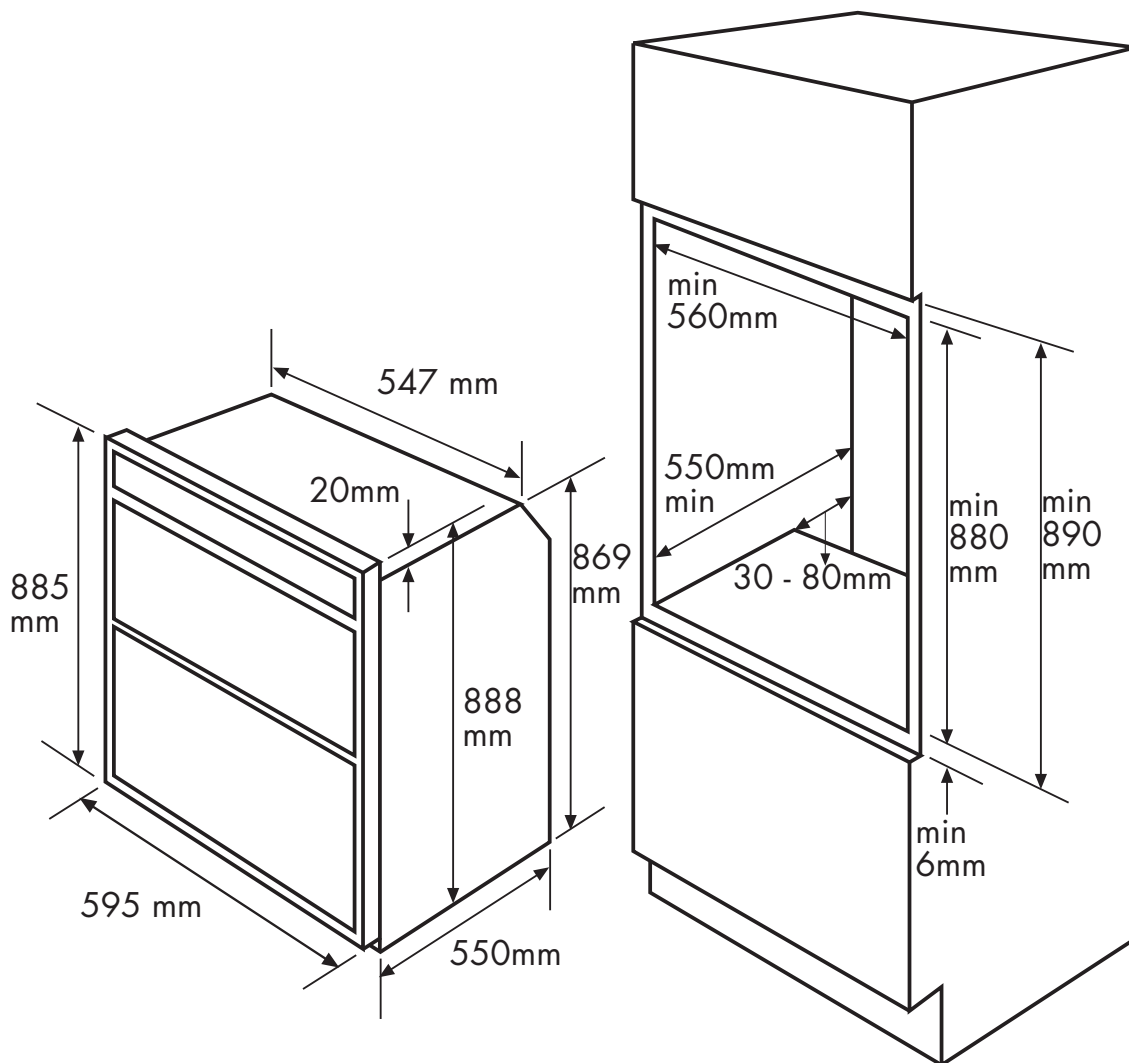

Installation

62

Step 2: Connect to the electricity supply

Warning: This appliance must be earthed.

The appliance must be installed by a competent electrician using a double pole control unit of 32 ampere minimum capacity with 3mm minimum contact separation at all poles.

We recommend that the appliance is connected by a qualified electrician, who will comply with the AS/NZS 3000:2000. and local regulation.

1. Access to the mains terminal is gained by opening the terminal block cover at the rear of the appliance (use a small flat-bladed screwdriver).
2. Connection should be made with suitable cable so as to comply with AS/NZS 3000:2000 and local regulations.
3. First strip the wires, then push the cable through the cable clamp in the terminal block cover.
4. Connect the cable to the terminal block, ensuring all cables and links are securely fixed and then tighten the cable clamp cover.
5. Close the terminal box, ensuring that the cover is engaged on the locking tabs.

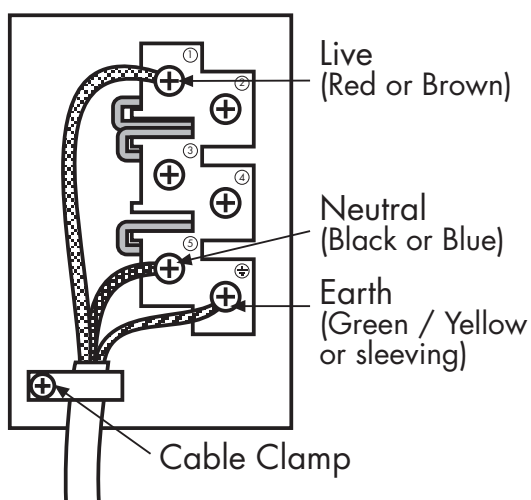

Minimum cable thickness must be 6mm².

Installation

63

Step 3: Check edging strip

The edging strip is factory fitted to the front side edges of the appliance front frame. This strip provides the cabinetry with extra protection from any escape of heat.

When installing the product, ensure that the edging strip is correctly located on the outer edges of the front frame, before positioning and securing the appliance to the cabinet.

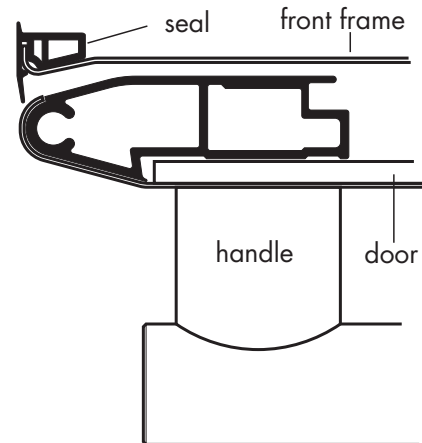

When securing the appliance, the fixing screws provided are driven through the edging strips into the cabinet - the seal will straighten up and sit flush to the cabinet when the screws are fully home.

Step 4: Secure appliance into housing unit

Insert appliance into cabinet.

Note: The unit housing the appliance must be appropriately fixed.

To secure appliance to housing unit

Note: Ensure that the appliance is centrally located.

Take care not to damage the appliance or cabinet.

There are 6 securing screws.

- Open the grill / top oven door, and screw 2 screws through the top corner holes in the front frame.
- With the grill / top oven door still open, screw 2 screws through the holes in the front frame, located under the grill compartment.
Close the grill / top oven door.
- Open the main oven door, and screw the remaining 2 screws through the bottom corner holes in the front frame.
Close the main oven door.

Installation Notes

64

i **Do not** attempt to install appliance if there is damage to:

- The door (bent).
- The hinges or latches (loosened or broken).
- The door seals and sealing surfaces.
- The lead or plug. (If fitted)
- Or if the appliance has been dropped.

Environmental Protection

We are committed to protecting the environment and operate an Environmental Management System which complies with BS EN ISO 14001

Disposal of packaging

- All our packaging materials are recyclable and environmentally friendly.
- Please help us to protect our environment by disposing of all packaging in an environmentally friendly manner.
- Please contact your local authority for the nearest recycling centre.

Caution: Packaging materials can pose a risk of suffocation - keep away from children.

IMPORTANT NOTICE

Please note the cooling fan fitted to this appliance is an integral part of its safety and functionality.

When the appliance is installed care must be taken that the cooling fans performance is not impeded by any objects coming into contact with it. (Installation pipes, leads etc) Care must also be taken that there is sufficient air flow at the rear of the appliance for the cooling fan to run at its optimum efficiency. (Particularly Built In appliances) See clearance dimensions in the installation section of the booklet.

During use the Appliance must never be disconnected from the Mains supply as this will seriously affect the safety and performance of the appliance, particularly in relation to surface temperatures becoming hot and gas operated parts not working efficiently.

The cooling fan is designed to run on after the control knob has been switched off to keep the front of the appliance and the controls cool until the appliance has naturally cooled itself.

Technical Information

65

Element \ Cavity	Top Oven @240v	Main Oven @240v	Genus Function
Base	765W	1000W	
Top	1000W	1000W	
Single grill	1800W	1800W	
Dual grill	2800W	2800W	
Fan element	N/A	2300W	
Cooling fan	80W		
			2.45GHz Frequency
			600W Power output
Lights	25W	10W	
Energy rating	C	A	
Country of destination	AUS		

Maximum Load: 7360W

Electrical supply: 220 - 240V ~ 50Hz

STOVES 900 GENUS - AU

ISSUE A

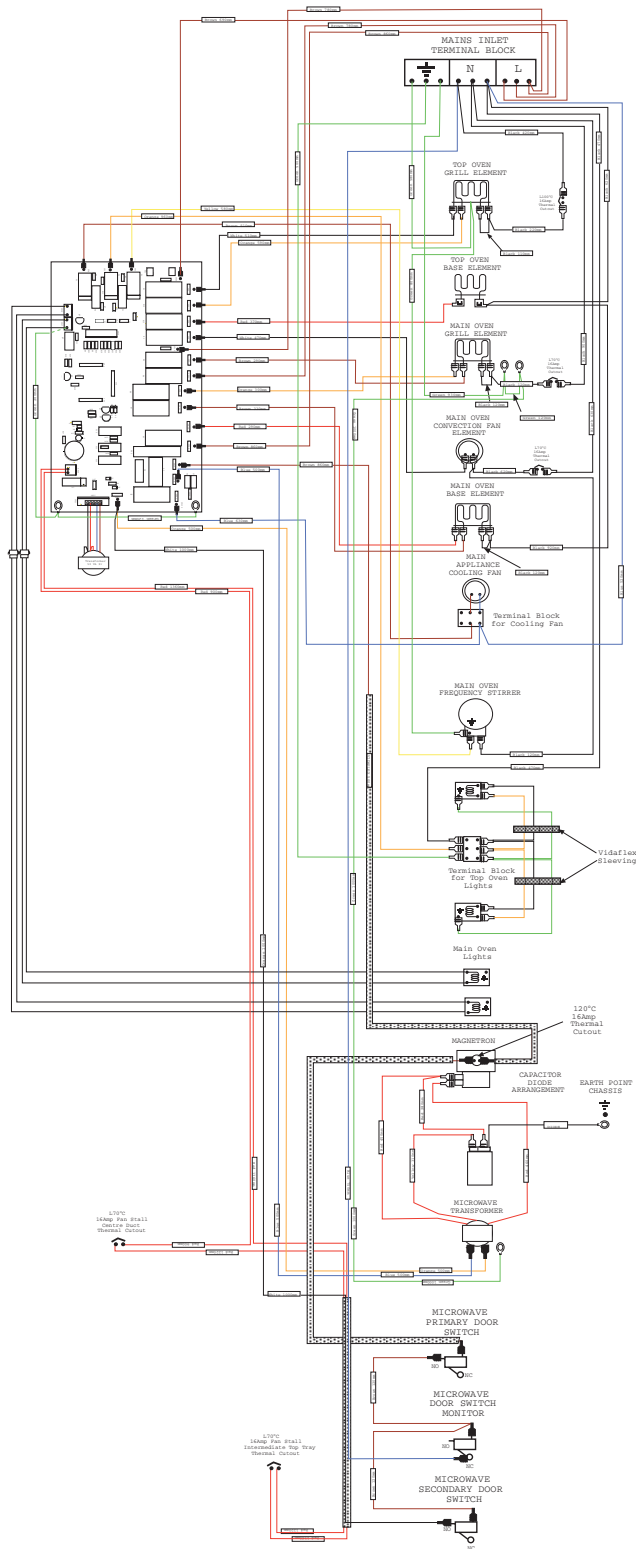

Notes

This area is a large rectangular frame with a thick brown border, designed for taking notes. It features a horizontal line near the top and a small triangular cutout at the bottom right corner.

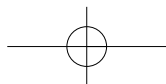
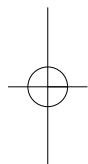
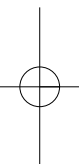

Notes

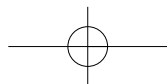
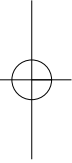
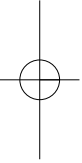

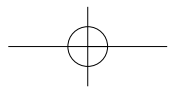
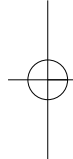
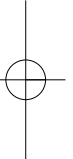
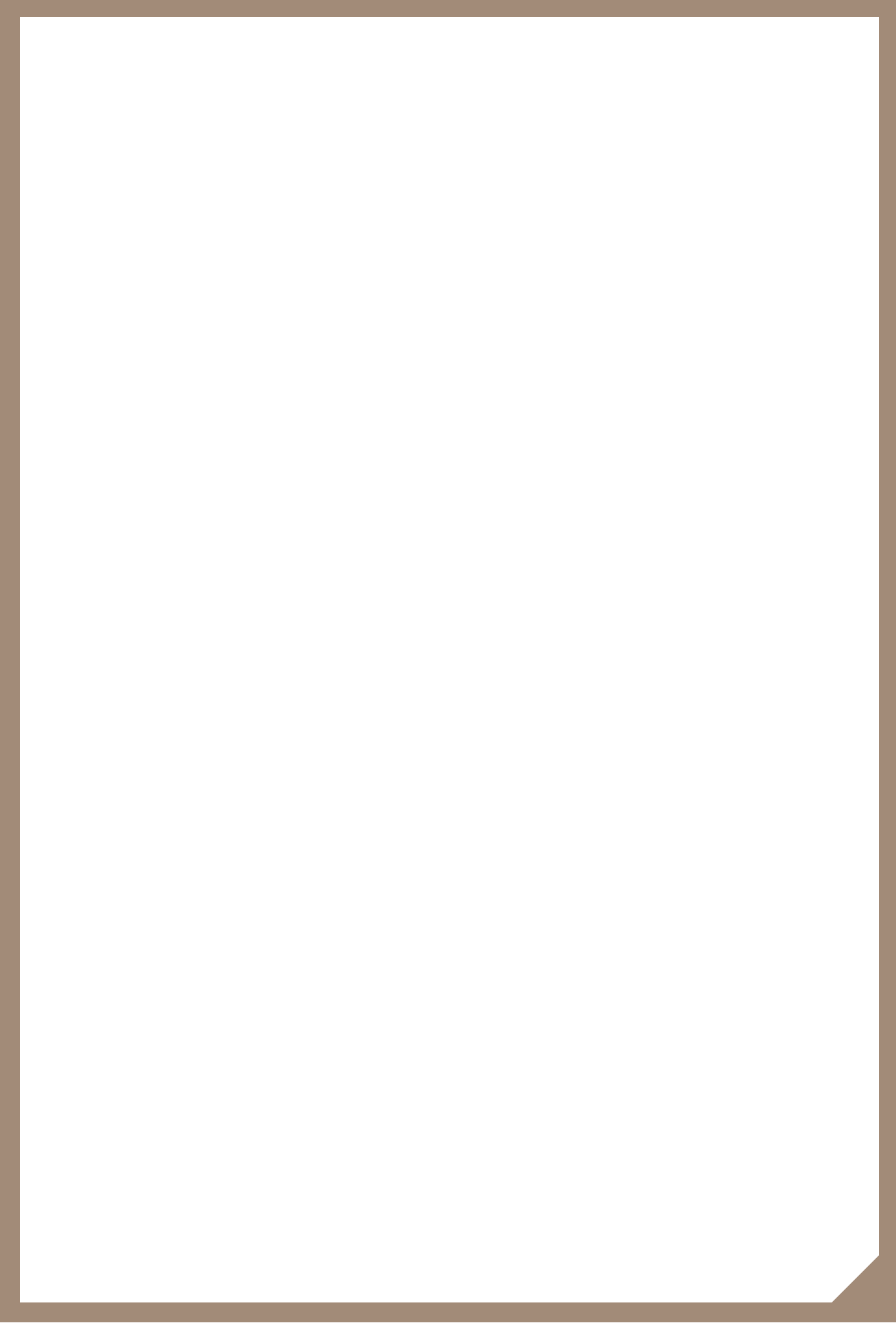

Contact Us

Calling for a service

If you should experience any problems with your cooker please contact your retailer or place of purchase.

Important note:

Service work is to be conducted by authorised persons only. It is also advisable that your cooker is checked regularly and maintained in good condition. An annual maintenance is recommended.

Always check the instruction book before calling a service agent to make sure you have not missed anything.

Glen Dimplex Australia Pty Ltd Customer Care:

Tel: 1-300-556-816

Before you contact a service agent, make sure that you have the following information to hand:

Model Number
Serial Number
Date of Purchase
Postcode



Glen Dimplex Australia, Unit 2, 205 Abbots Road, Dandenong South, Victoria 3175
Australia

e-mail: sales@glendimplex.com.au
web: www.glendimplex.com.au

08 27317 02 © 03.2008
Built In Genus
Model Names: Genus 900